

PANNELLO DA 930x1992 kg/cad zn. 17,91 (kg/m<sup>2</sup> 9,67)  
 #62x66  
 PIATTO VERTICALE 25x2  
 TONDO ORIZZONTALE Ø4,5  
 CORNICE 25x4

PIANTANA -60x7 lg. 1210 (da inghisare) kg/cad zn. 4,4

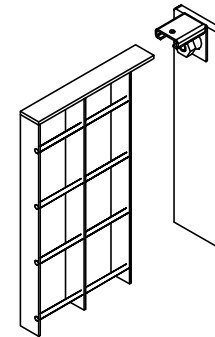

SQUADRETTA TELESCOPICA RETTILINEA

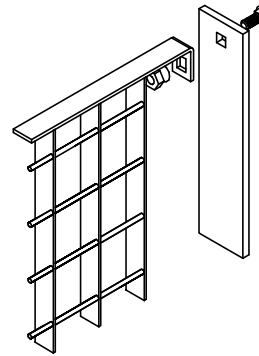
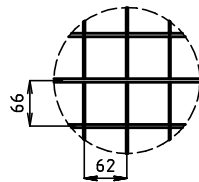
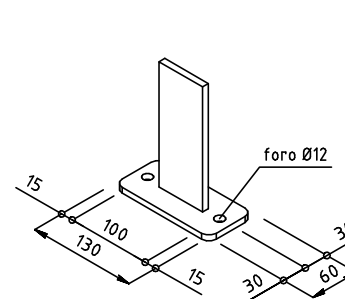

PIANTANA -60x7 lg. 1011 (da tassellare) kg/cad zn. 4,2  
 DIMENSIONE PIASTRA 130x60x7

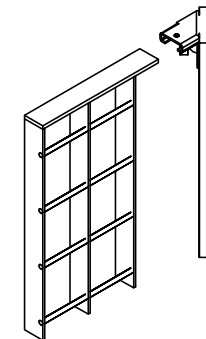

SQUADRETTA TELESCOPICA 45°

REVISIONE/REVISION	DATA/DATE	DESCRIZIONE/DESCRIPTION	DIS./PREPARED	APPROV./APPROVED
1	08-07-2013	MODIFICATO Ø TONDO ORIZZONTALE D 5 A 4,5	BROGGI	M.G.
0	06-05-2013	PRIMA EMISSIONE	BROGGI	M.G.

  

 22040 ANZANO DEL PARCO (CO) - Italia Tel. 031 63.32.211 r.a. - Fax. 031 63.32.233 www.nuovodefim.com e-mail: orsogrill@nuovodefim.com	<b>PLEIONE</b> <b>PANNELLO h.930x1992</b> <b>PIANTANA -60x7 lg.1210/1011</b>	<b>DIS./DWG.N°</b> <b>PLE021</b>	<b>FOGLIO SHEET</b> <b>1</b>
		<b>REVISIONE/REVISED</b> 01	<b>SCALE</b> 1/15
CLIENTE/CUSTOMER <b>Nuova Defim - Orsogrill</b>		QUESTO DISEGNO E' DI PROPRIETA' DELLA NUOVA DEFIM - ORSOGRILL ED E' VINCOLATO SECONDO LE NORME DI LEGGE. THIS DRAWING IS THE PROPERTY OF NUOVA DEFIM - ORSOGRILL WHO WILL SAFEGUARD ITS RIGHTS ACCORDING TO THE CIVIL AND PENAL PROVISIONS OF THE LAW.	

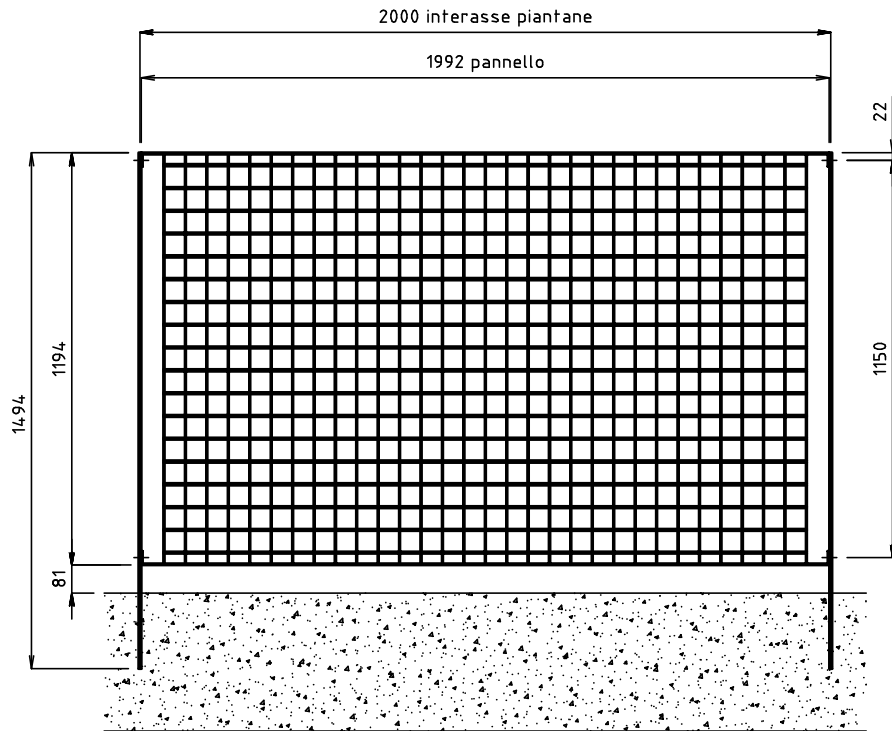

PANNELLO DA 1194x1992 kg/cad zn. 22,07 (kg/m<sup>2</sup> 9,28)  
 #62x66  
 PIATTO VERTICALE 25x2  
 TONDO ORIZZONTALE Ø4,5  
 CORNICE 25x4

PIANTANA -60x7 lg. 1494 (da inghisare) kg/cad zn. 5,4

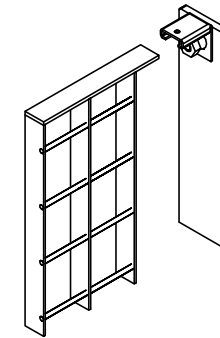
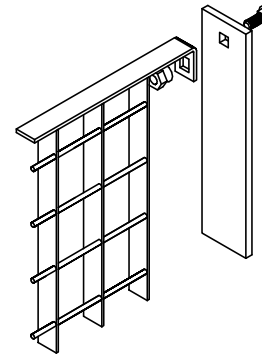
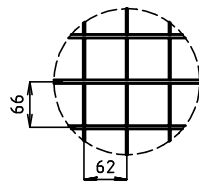

SQUADRETTA TELESOPICA RETTILINEA

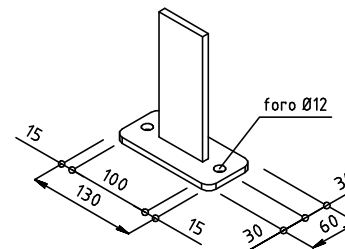

PIANTANA -60x7 lg. 1275 (da tassellare) kg/cad 5,2  
 DIMENSIONE PIASTRA 130x60x7

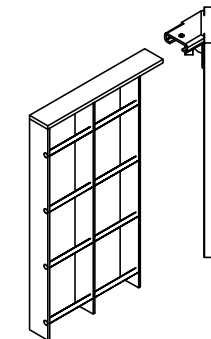

SQUADRETTA TELESOPICA 45°

REVISIONE REVISION	DATA/DATE	DESCRIZIONE/DESCRIPTION	DIS./PREPARED	APPROV./APPROVED
1	09-07-2013	MODIFICATO Ø TONDO ORIZZONTALE DA 5 A 4,5	BROGGI	M.G.
0	06-05-2013	PRIMA EMISSIONE	BROGGI	M.G.

 22040 ANZANO DEL PARCO (CO) - Italia Tel. 031 63.32.211 r.a. - Fax 031 63.32.233 www.nuovodefim.com e-mail: orsogrill@nuovodefim.com	<b>PLEIONE</b> <b>PANNELLO h.1194x1992</b> <b>PIANTANA -60x7 lg.1494/1275</b>	<b>DIS./DWG.N°</b> <b>PLE022</b>	<b>FOGLIO</b> <b>SHEET</b> <b>1</b>
		<b>REVISIONE/REVISED</b> 01	<b>COMM.</b> <b>JOB</b> Nuova Defim - Orsogrill
<small>QUESTO DISEGNO E' DI PROPRIETA' DELLA NUOVA DEFIM - ORSOGRILL ED E' VINCOLATO SECONDO LE NORME DI LEGGE.          THIS DRAWING IS THE PROPERTY OF NUOVA DEFIM - ORSOGRILL WHO WILL SAFEGUARD ITS RIGHTS ACCORDING TO THE CIVIL AND PENAL PROVISIONS OF THE LAW.</small>		<b>SCALA</b> SCALE 1/15	

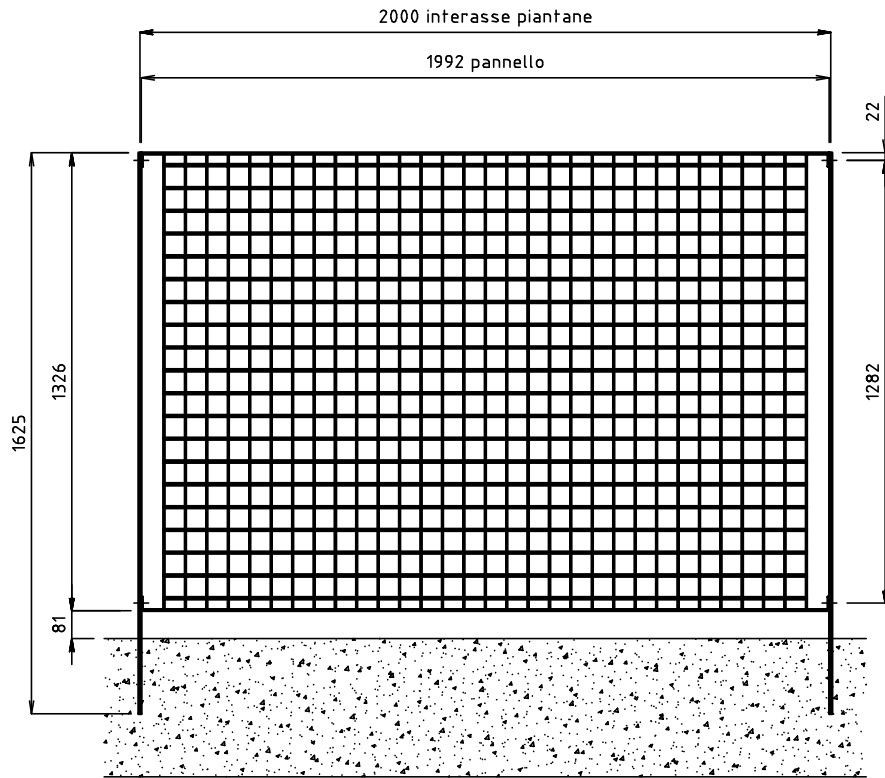

PANNELLO DA 1326x1992 kg/cad zn. 24,14 (kg/m<sup>2</sup> 9,14)  
 #62x66  
 PIATTO VERTICALE 25x2  
 TONDO ORIZZONTALE Ø4,5  
 CORNICE 25x4  
 PIANTANA -60x7 (g. 1625 (da inghisare) kg/cad zn. 5,9

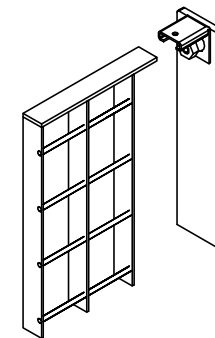
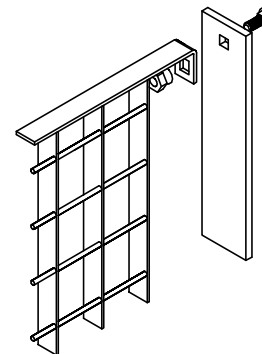
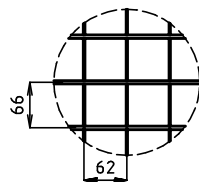

SQUADRETTA TELESCOPICA RETTILINEA

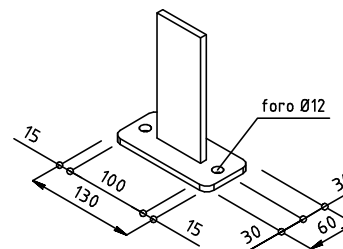

PIANTANA -60x7 lg. 1407 (da tassellare) kg/cad zn. 5,7  
 DIMENSIONE PIASTRA 130x60x7

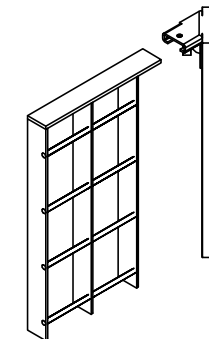

SQUADRETTA TELESCOPICA 45°

1	09-07-2013	MODIFICATO Ø TONDO ORIZZONTALE DA 5 A 4,5	BROGGI	M.G.
0	07-05-2013	PRIMA EMISSIONE	BROGGI	M.G.
REVISIONE REVISION	DATA/DATE	DESCRIZIONE/DESCRIPTION	DIS./PREPARED	APPROV./APPROVED
			<b>PLEIONE</b> <b>PANNELLO h.1326x1992</b> <b>PIANTANA -60x7 lg.1625/1407</b>	
22040 ANZANO DEL PARGO (CO) - Italia Tel. 031 63.32.211 r.a. - Fax 031 63.32.233 www.nuovodefim.com e-mail: orsogril@nuovodefim.com			DIS.N°/DWG.N° <b>PLE023</b> 1 REVISIONE/REVISED 01	
CLIENTE/CUSTOMER <b>Nuova Defim - Orsogril</b>			COMM. JOB SCALE 1/15	

QUESTO DISEGNO E' DI PROPRIETA' DELLA NUOVA DEFIM - ORSOGRIL ED E' VINCOLATO SECONDO LE NORME DI LEGGE.  
 THIS DRAWING IS THE PROPERTY OF NUOVA DEFIM - ORSOGRIL WHO WILL SAFEGUARD ITS RIGHTS ACCORDING TO THE CIVIL AND PENAL PROVISIONS OF THE LAW.

Disegno eseguito con CAD. Non Revisionare manualmente./Drawing made by CAD. Do not modify manually.

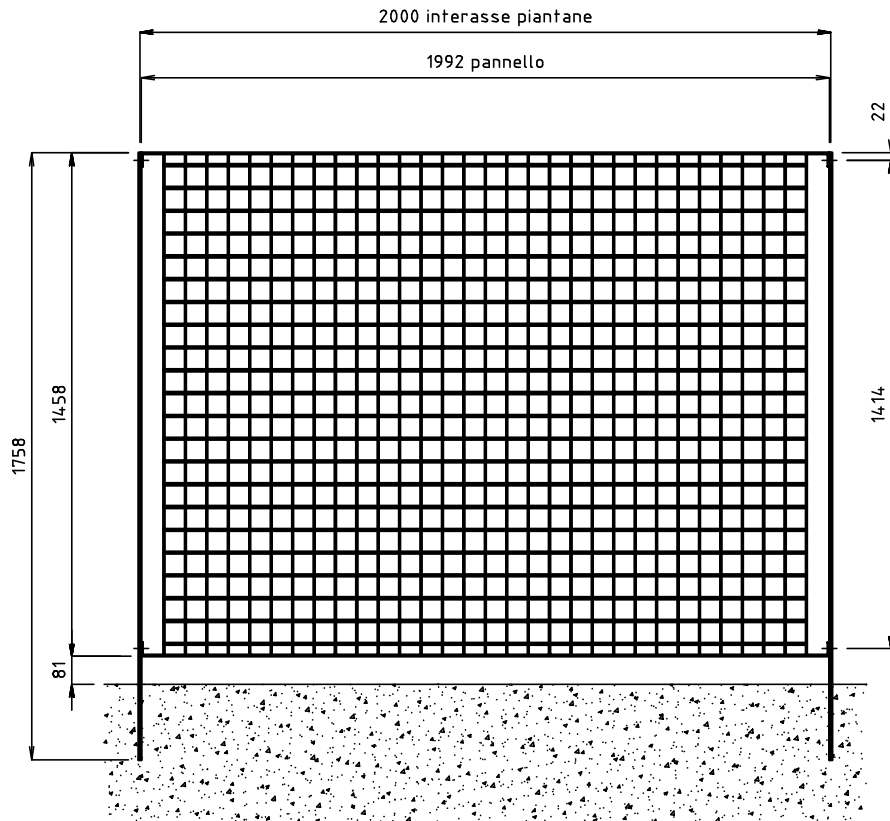

PANNELLO DA 1458x1992 kg/cad zn. 26,23 (kg/m<sup>2</sup> 9,03)  
 #62x66  
 PIATTO VERTICALE 25x2  
 TONDO ORIZZONTALE Ø4,5  
 CORNICE 25x4  
 PIANTANA -60x7 lg. 1758 (da inghisare) kg/cad zn. 6,4

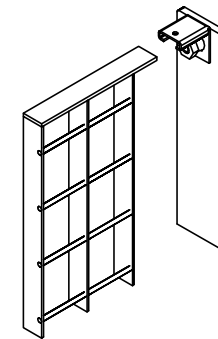
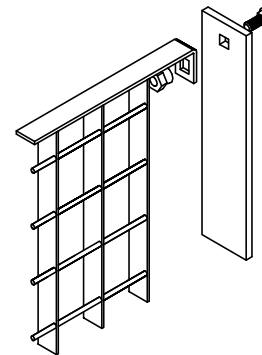
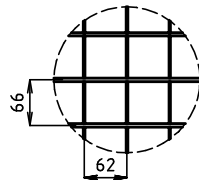

SQUADRETTA TELESCOPICA RETTILINEA

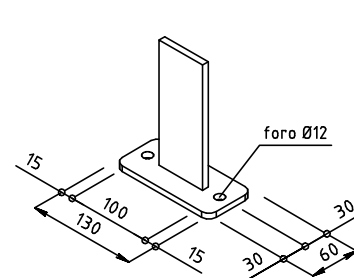

PIANTANA -60x7 lg. 1539 (da tassellare) kg/cad zn. 6,1  
 DIMENSIONE PIASTRA 130x60x7

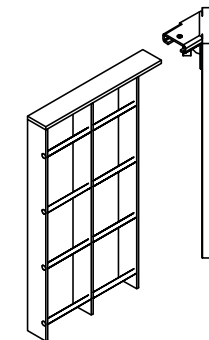

SQUADRETTA TELESCOPICA 45°

1	09-07-2013	MODIFICATO Ø TONDO ORIZZONTALE DA 5 A 4,5	BROGGI	M.G.
0	07-05-2013	PRIMA EMISSIONE	BROGGI	M.G.
REVISIONE REVISION	DATA/DATE	DESCRIZIONE/DESCRIPTION	DIS./PREPARED	APPROV./APPROVED
			<b>PLEIONE</b> <b>PANNELLO h.1458x1992</b> <b>PIANTANA -60x7 lg.1758/1539</b>	
22040 ANZANO DEL PARGO (CO) - Italia Tel. 031 63.32.211 r.a. - Fax. 031 63.32.233 www.nuovodefim.com e-mail: orsogrill@nuovodefim.com			<b>DIS./DWGN</b> <b>PLE024</b> <b>1</b> REVISIONE/REVISED 01	
CLIENTE CUSTOMER			<b>Nuova Defim - Orsogrill</b>	
QUESTO DISEGNO E' DI PROPRIETA' DELLA NUOVA DEFIM - ORSOGRILL ED E' VINCOLATO SECONDO LE NORME DI LEGGE. THIS DRAWING IS THE PROPERTY OF NUOVA DEFIM - ORSOGRILL WHO WILL SAFEGUARD ITS RIGHTS ACCORDING TO THE CIVIL AND PENAL PROVISIONS OF THE LAW.				FOGLIO SHEET 1/15

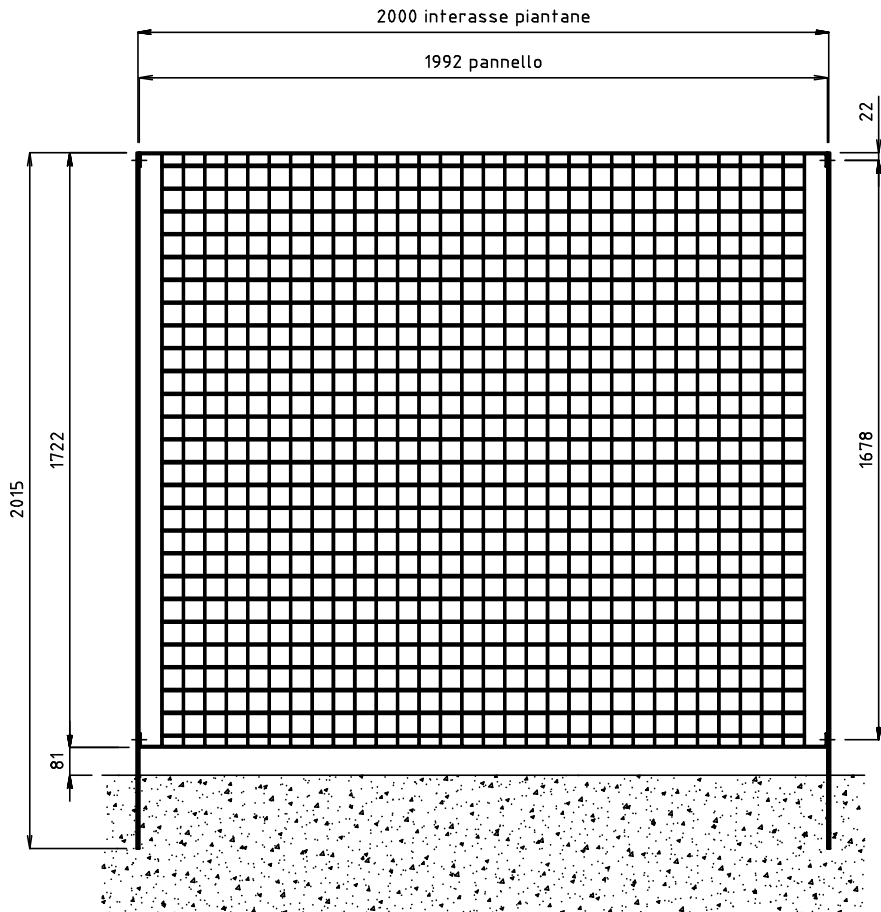

PANNELLO DA 1722x1992 kg/cad zn. 30,39 (kg/m<sup>2</sup> 8,86)  
 #62x66  
 PIATTO VERTICALE 25x2  
 TONDO ORIZZONTALE Ø4,5  
 CORNICE 25x4

PIANTANA -60x7 lg. 2015 (da inghisare) kg/cad zn 7,3

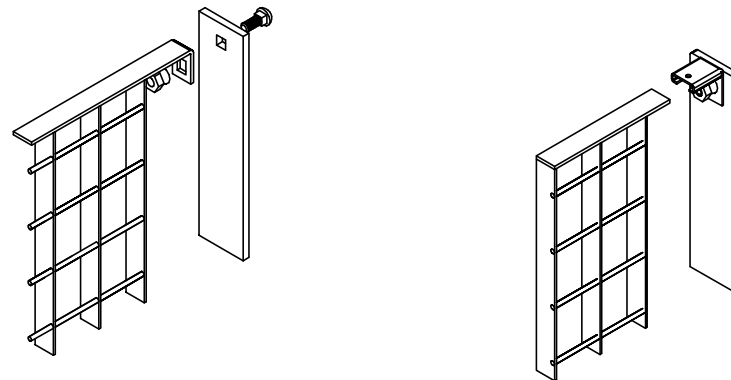
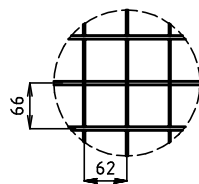

SQUADRETTA TELESCOPICA RETTILINEA

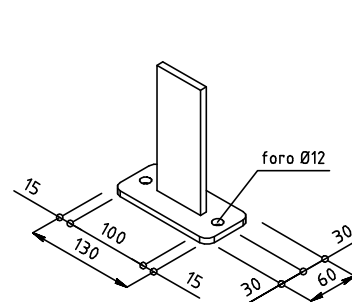

PIANTANA -60x7 lg. 1803 (da fassellare) kg/cad 7,1  
 DIMENSIONE PIASTRA 130x60x7

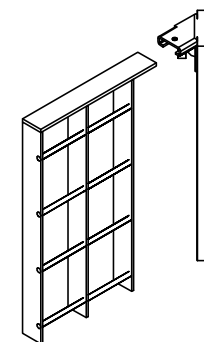

SQUADRETTA TELESCOPICA 45°

1	09-07-2013	MODIFICATO Ø TONDO ORIZZONTALE DA 5 A 4,5	BROGGI	M.G.
0	08-05-2013	PRIMA EMISSIONE	BROGGI	M.G.
REVISIONE REVISION	DATA/DATE	DESCRIZIONE/DESCRIPTION	DIS./PREPARED	APPROV./APPROVED
			<b>PLEIONE</b> <b>PANNELLO h.1722x1992</b> <b>PIANTANA -60x7 lg.2015/1803</b>	
22040 ANZANO DEL PARCO (CO) - Italia Tel. 031 63.32.211 r.a. - Fax. 031 63.32.233 www.nuovodefim.com e-mail: orsogril@nuovodefim.com			<b>DIS./DWG.N°</b> <b>FOGLIO SHEET</b> <b>PLE025 1</b> REVISIONE/REVISED 01	
CLIENTE/CUSTOMER <b>Nuova Defim - Orsogril</b>			COMM. JOB SCALE 1/15	

QUESTO DISEGNO E' DI PROPRIETA' DELLA NUOVA DEFIM - ORSOGRIL ED E' VINCOLATO SECONDO LE NORME DI LEGGE.  
 THIS DRAWING IS THE PROPERTY OF NUOVA DEFIM - ORSOGRIL WHO WILL SAFEGUARD ITS RIGHTS ACCORDING TO THE CIVIL AND PENAL PROVISIONS OF THE LAW.

Disegno eseguito con CAD. Non Revisionare manualmente./Drawing made by CAD. Do not modify manually.

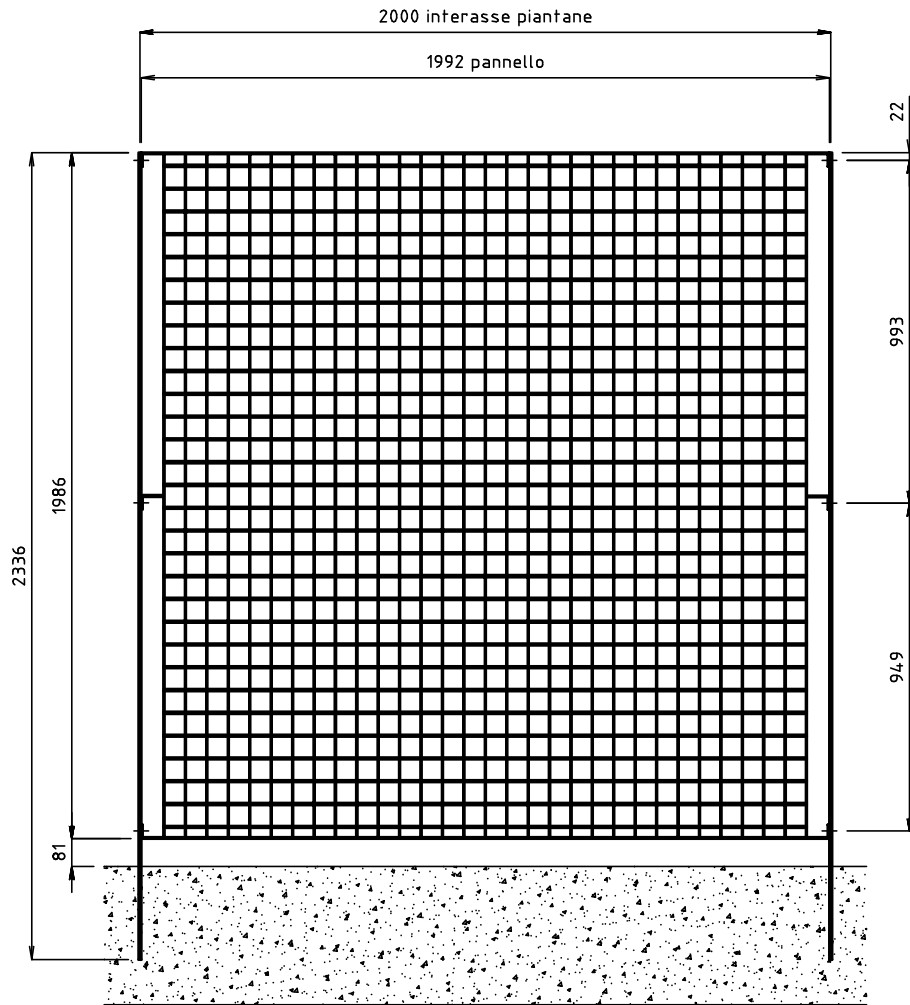

PANNELLO DA 1986x1992 kg/cad zn. 34,54 (kg/m<sup>2</sup> 8,73)  
 #62x66  
 PIATTO VERTICALE 25x2  
 TONDO ORIZZONTALE Ø4,5  
 CORNICE 25x4

PIANTANA -60x7 lg. 2336 (da inghisare) kg/cad zn. 8,5

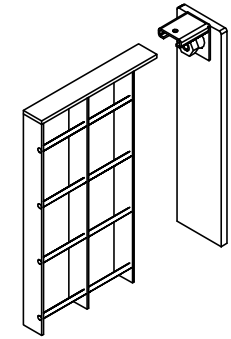
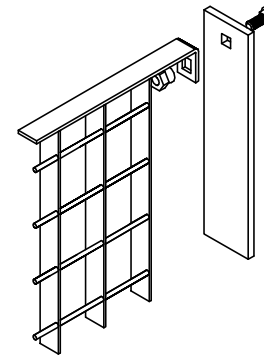
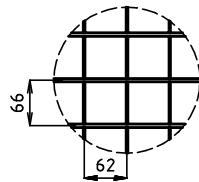

SQUADRETTA TELESCOPICA RETTILINEA

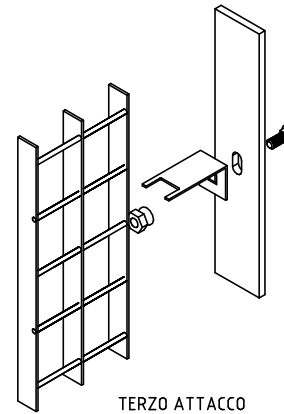

TERZO ATTACCO

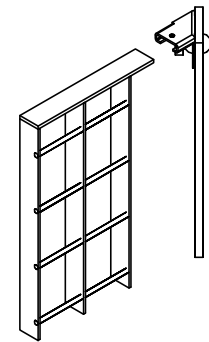

SQUADRETTA TELESCOPICA 45°

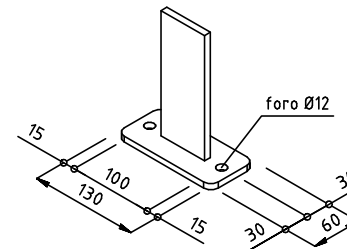

PIANTANA -60x7 lg. 2067 (da tassellare) kg/cad zn. 8,0  
 DIMENSIONE PIASTRA 130x60x7

REVISIONE/REVISION	DATA/DATE	DESCRIZIONE/DESCRIPTION	DIS./PREPARED	APPROV./APPROVED
1	09-07-2013	MODIFICATO Ø TONDO ORIZZONTALE DA 5 A 4,5	BROGGI	M.G.
0	08-05-2013	PRIMA EMISSIONE	BROGGI	M.G.

	<b>PLEIONE</b> <b>PANNELLO h.1986x1992</b> <b>PIANTANA -60x7 lg.2336/2067</b>	<b>DIS./DWG.N°</b> <b>PLE026</b>	<b>FOGLIO</b> <b>SHEET</b> <b>1</b>
		<b>REVISIONE/REVISED</b> <b>01</b>	<b>COMM.</b> <b>JOB</b> <b>Nuova Defim - Orsogril</b>
<small>22040 ANZANO DEL PARDO (CO) - Italia          Tel: 031 63.32.211 r.a. - Fax: 031 63.32.233          www.nuovodefim.com e-mail: orsogril@nuovodefim.com</small>		<small>CLIENTE/CUSTOMER</small>	<small>SCALA/SCALE</small> 1/15

QUESTO DISEGNO E' DI PROPRIETA' DELLA NUOVA DEFIM - ORSOGRIL ED E' VINCOLATO SECONDO LE NORME DI LEGGE.  
 THIS DRAWING IS THE PROPERTY OF NUOVA DEFIM - ORSOGRIL WHO WILL SAFEGUARD ITS RIGHTS ACCORDING TO THE CIVIL AND PENAL PROVISIONS OF THE LAW.

Disegno eseguito con CAD. Non Revisionare manualmente./Drawing made by CAD. Do not modify manually.

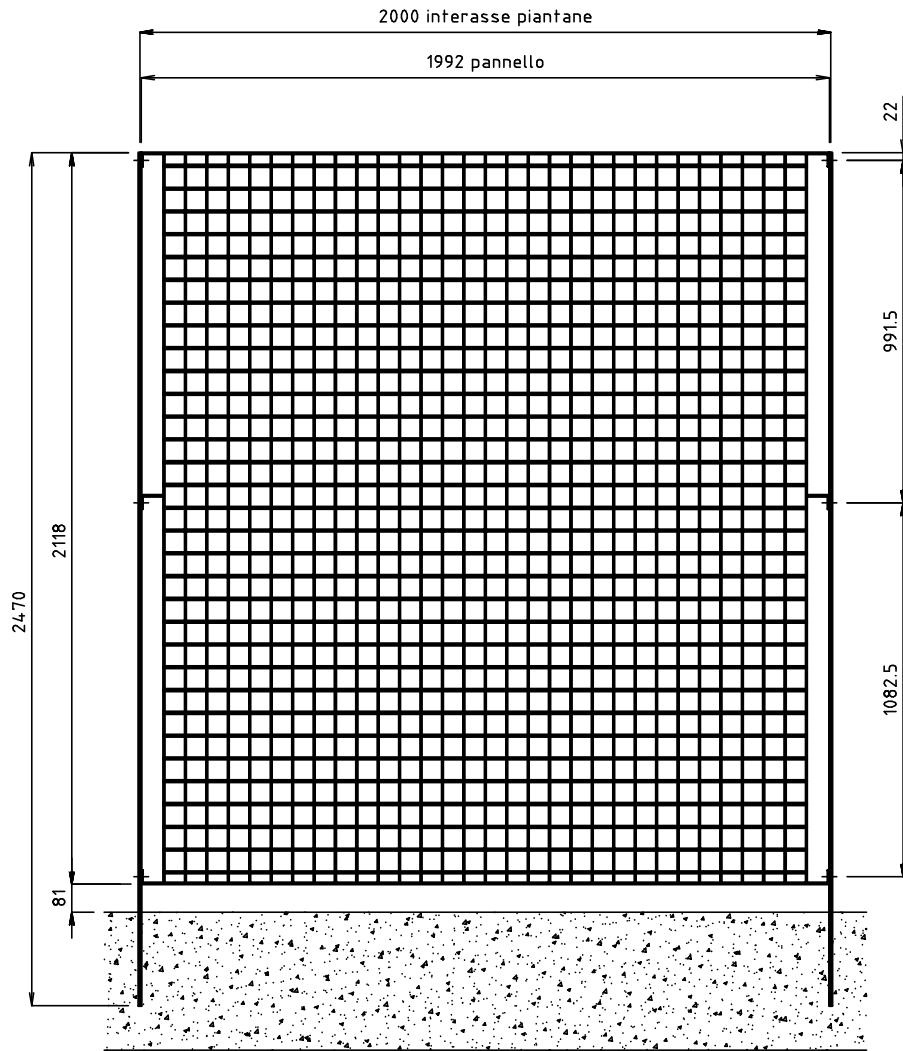

PANNELLO DA 2118x1992 kg/cad zn. 36,62 (kg/m<sup>2</sup> 8,68)  
 #62x66  
 PIATTO VERTICALE 25x2  
 TONDO ORIZZONTALE Ø4,5  
 CORNICE 25x4

PIANTANA -80x8 lg. 2470 (da inghisare) kg/cad zn. 13,7

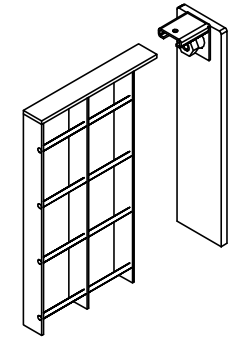
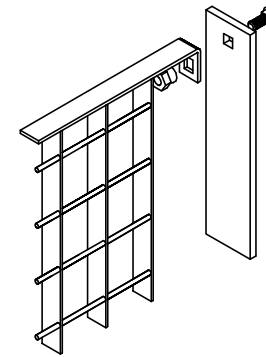
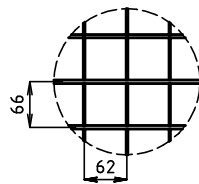

SQUADRETTA TELESCOPICA RETTILINEA

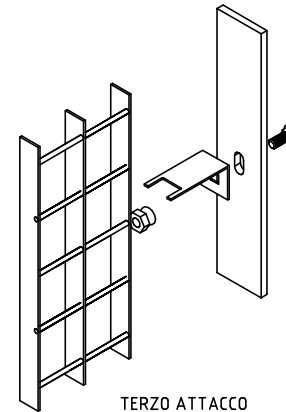

TERZO ATTACCO

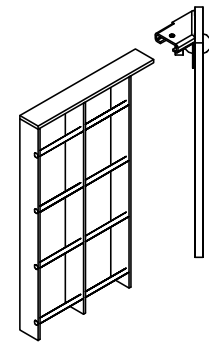

SQUADRETTA TELESCOPICA 45°

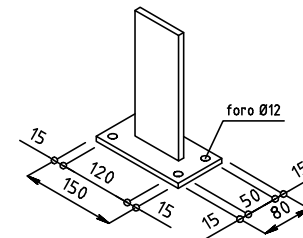

PIANTANA -80x8 lg. 2199 (da tassellare) kg/cad zn. 12,9  
 DIMENSIONE PIASTRA 150x80x8

REVISIONE/REVISION	DATA/DATE	DESCRIZIONE/DESCRIPTION	DIS./PREPARED	APPROV./APPROVED
2	27-09-2013	MODIFICATO SP. PIANTANA E DIMENSIONI PIASTRA DI BASE	BROGGI	M.G.
1	09-07-2013	MODIFICATO Ø TONDO ORIZZONTALE DA 5 A 4,5	BROGGI	M.G.
0	08-05-2013	PRIMA EMISSIONE	BROGGI	M.G.

	<b>PLEIONE</b> <b>PANNELLO h.2118x1992</b> <b>PIANTANA -80x8 lg.2470/2199</b>	<b>DESIGN/DWG.N°</b> <b>PLE027</b>	<b>FOGLIO SHEET</b> <b>1</b>
	<small>22040 ANZANO DEL PARCO (CO) - Italia          Tel. 031 63.32.211 r.a. - Fax. 031 63.32.233          www.nuovodefim.com e-mail: orsogril@nuovodefim.com</small>	<b>CLIENTE/CUSTOMER</b> <b>Nuova Defim - Orsogril</b>	<b>REVISIONE/REVISED</b> 01/12/13

QUESTO DISEGNO E' DI PROPRIETA' DELLA NUOVA DEFIM - ORSOGRIL ED E' VINCOLATO SECONDO LE NORME DI LEGGE.  
 THIS DRAWING IS THE PROPERTY OF NUOVA DEFIM - ORSOGRIL WHO WILL SAFEGUARD ITS RIGHTS ACCORDING TO THE CIVIL AND PENAL PROVISIONS OF THE LAW.

Disegno eseguito con CAD. Non Revisionare manualmente./Drawing made by CAD. Do not modify manually.

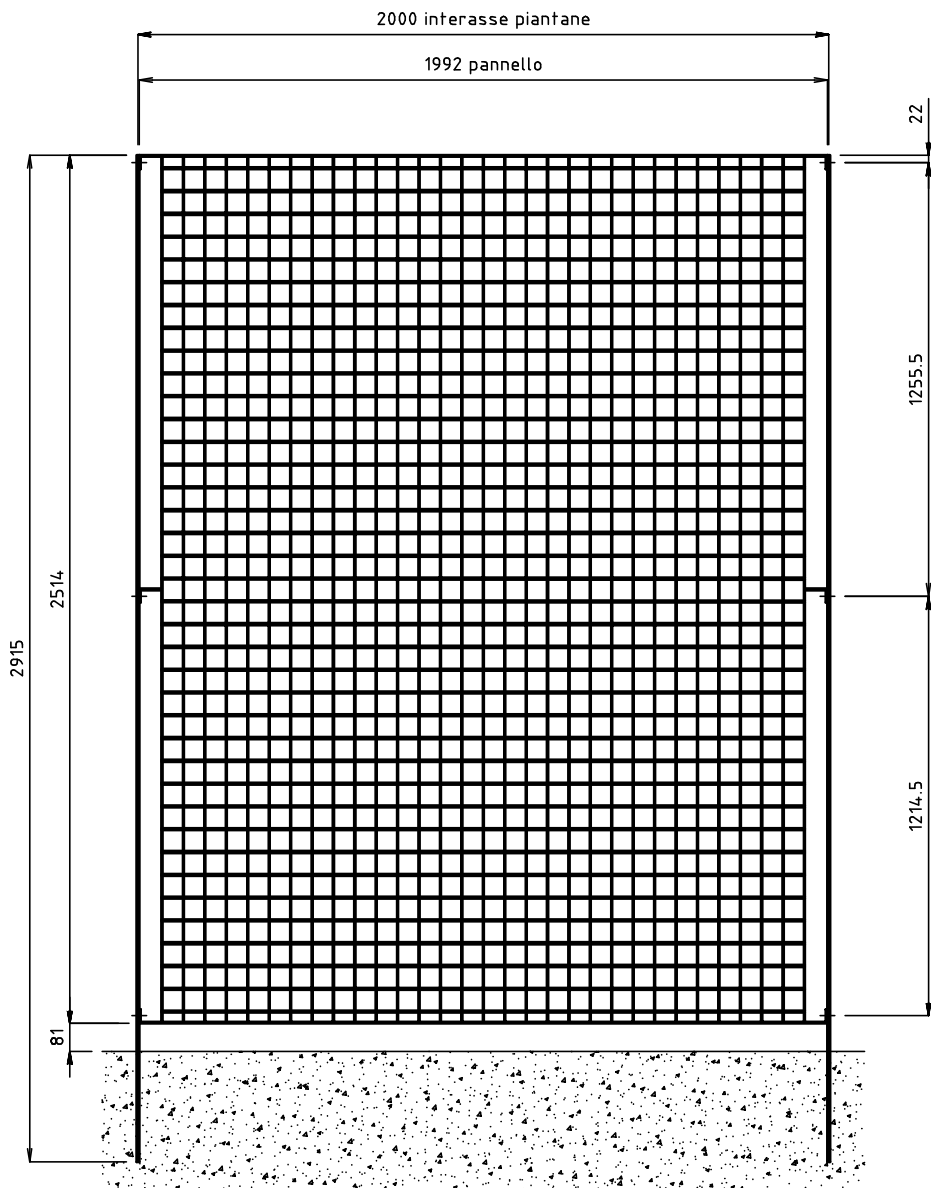

PANNELLO DA 2514x1992 kg/cad zn. 42,87 (kg/m<sup>2</sup> 8,56)  
 #62x66  
 PIATTO VERTICALE 25x2  
 TONDO ORIZZONTALE Ø4,5  
 CORNICE 25x4

PIANTANA -80x8 lg. 2915 (da inghisare) kg/cad zn. 16,1

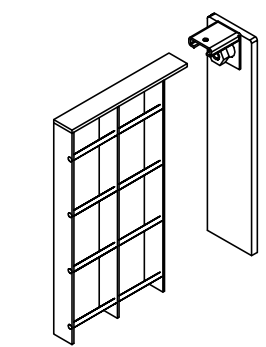
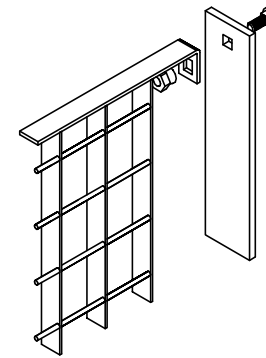
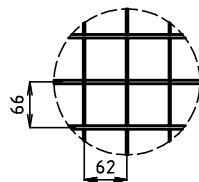

SQUADRETTA TELESCOPICA RETTILINEA

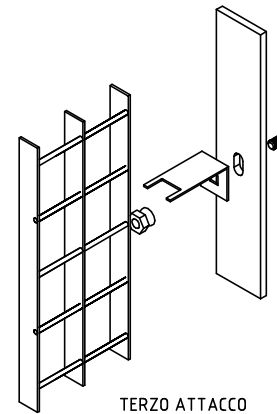

TERZO ATTACCO

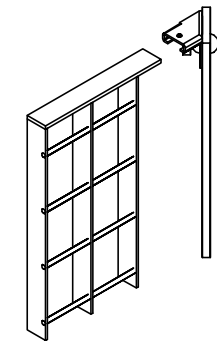

SQUADRETTA TELESCOPICA 45°

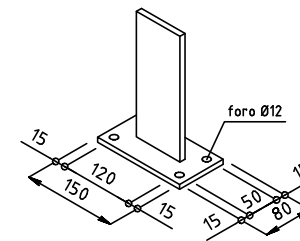

PIANTANA -80x8 lg. 2595 (da tassellare) kg/cad zn. 15,1  
 DIMENSIONE PIASTRA 150x80x8

REVISIONE/REVISION	DATA/DATE	DESCRIZIONE/DESCRIPTION	DIS./PREPARED	APPROV./APPROVED
2	27-09-2013	MODIFICATO SP. PIANTANA E DIMENSIONI PIASTRA DI BASE	BROGGI	M.G.
1	09-07-2013	MODIFICATO Ø TONDO ORIZZONTALE DA 5 A 4,5	BROGGI	M.G.
0	08-05-2013	PRIMA EMISSIONE	BROGGI	M.G.

 22040 ANZANO DEL PARCO (CO) - Italia Tel. 031 63.32.211 r.a. - Fax 031 63.32.233 www.nuovodefim.com e-mail: orsogril@nuovodefim.com	<b>PLEIONE</b> <b>PANNELLO h.2514x1992</b> <b>PIANTANA -80x8 lg.2915/2595</b>	<b>DIS./DWG.N°</b> <b>PLE028</b>	<b>FOGLIO SHEET</b> <b>1</b>
		<b>REVISIONE/REVISED</b> 01   12	<b>SCALE</b> 1/15
<small>QUESTO DISEGNO È DI PROPRIETÀ DELLA NUOVA DEFIM - ORSOGRIL ED È VINCOLATO SECONDO LE NORME DI LEGGE. THIS DRAWING IS THE PROPERTY OF NUOVA DEFIM - ORSOGRIL WHO WILL SAFEGUARD ITS RIGHTS ACCORDING TO THE CIVIL AND PENAL PROVISIONS OF THE LAW.</small>		<small>CLIENTE/CUSTOMER</small> <b>Nuova Defim - Orsogril </b>	